

## SERIES DRG7

- Rotary sealed miniature encoders
- 7x7 mm<sup>2</sup>

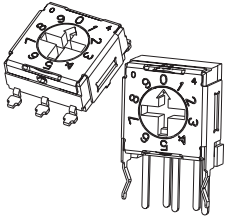

## CHARACTERISTICS

- 7x7 mm<sup>2</sup> by 4 mm high
- SMD models 3.6 mm high
- UL94V-0 Materials
- Binary Decimal and Hexadecimal codes
- Gold plated contacts
- Earth terminal available
- O ring seal for washing
- Tape & Reel for SMD models
- Tin plated terminals

## SPECIFICATIONS

**Rating:** Switching 100mA, @ 5 VDC  
 Non Switching 100 mA @ 50 VDC  
**Contact Resistance:** 200 m Ω max, 1.5 mA  
**Insulation Resistance:** 100 M Ω @100VDC  
**Dielectric Strength:** 250 VDC, 1 Min  
**Temperature:** Operating -25°C to + 70°C  
 Storage -25°C to +85°C  
**Life:** 10000 Operations  
**Operating Force:** 510 Gr/cm Max  
**Vibration:** per Mil - STD-202F, method 204D  
**Solderability:** After flux 235 ±5°C for 2 ±0.5 secs  
 95% coverage

## HOW TO ORDER

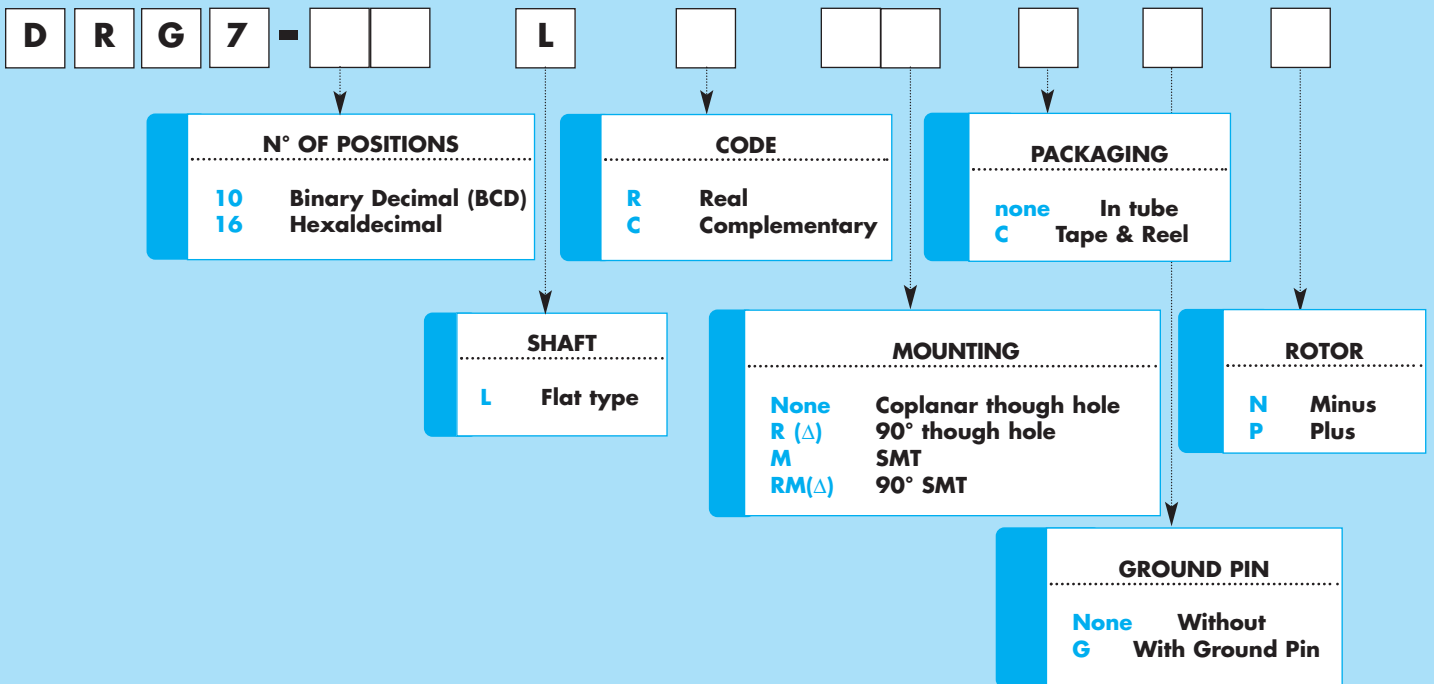

DIP SWITCHES

(Δ) Not available with ground pin

## SERIES DRG7

### NUMBER OF POSITIONS

**10**  
**BCD**  
**(1 out of 10 Codes)**

PIN N°	POSITION									
	0	1	2	3	4	5	6	7	8	9
1	○	●	○	○	○	○	○	○	○	○
2	○	○	○	○	○	○	○	○	○	○
4	○	○	○	○	○	○	○	○	○	○
8	○	○	○	○	○	○	○	○	○	○

Marked 0 - 9 on the face

**16**  
**Hexadecimal**  
**(1 out of 16 Codes)**

PIN N°	POSITION															
	0	1	2	3	4	5	6	7	8	9	A	B	C	D	E	F
1	○	●	○	○	○	○	○	○	○	○	○	○	○	○	○	○
2	○	○	○	○	○	○	○	○	○	○	○	○	○	○	○	○
4	○	○	○	○	○	○	○	○	○	○	○	○	○	○	○	○
8	○	○	○	○	○	○	○	○	○	○	○	○	○	○	○	○

Marked 0 - 9, A, B, C, E, F on the face

Colour coding for rotors

	Real Code	Complementary Code
<b>Rotor Colour</b>	<b>Red</b>	<b>Green</b>

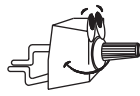

## SERIES DRG7

### MOUNTING AND DIMENSIONS

**none**  
Coplanar

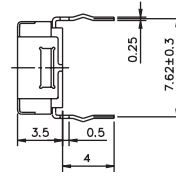
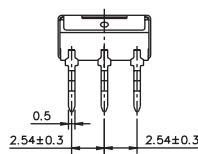

#### P.C.B. MOUNTING HOLE

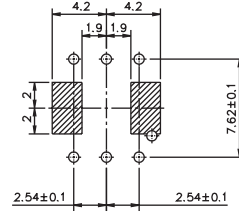

Part N° shown: DRG7-16LRP

**none - G**  
Coplanar with  
Ground Pin

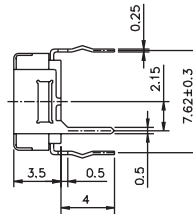
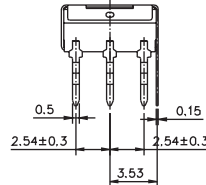
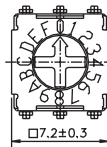

#### P.C.B. MOUNTING HOLE

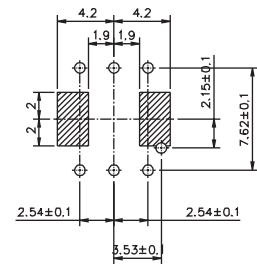

Part N° shown: DRG7-16LGP

**M**  
Coplanar SMT

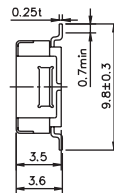
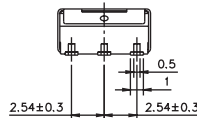
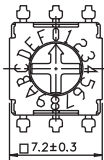

#### P.C.B. LAYOUT (top view)

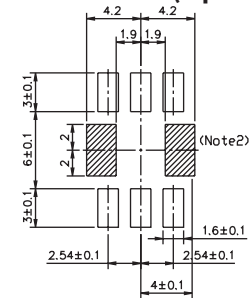

Part N° shown: DRG7-16LRCP

**M - G**  
Coplanar SMT with  
Ground Pin

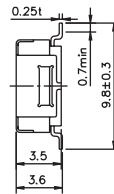
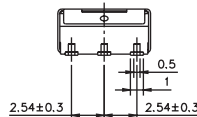
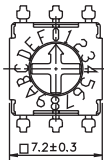

#### P.C.B. LAYOUT (top view)

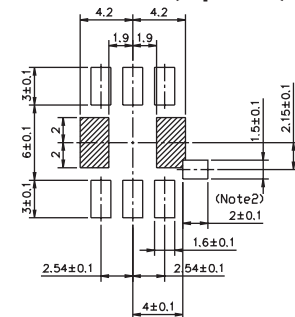

Part N° shown: DRG7-16LRCGP

## SERIES DRG7

### MODEL AND DIMENSIONS

**R**

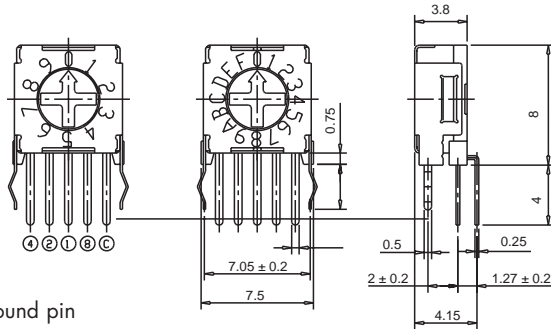

Not available with ground pin

#### P.C.B. MOUNTING HOLE

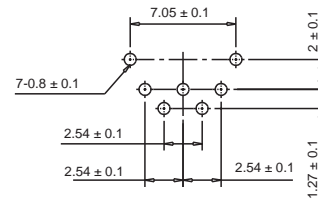

**RM**

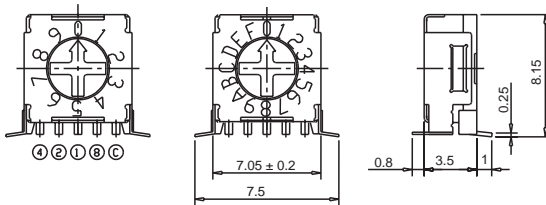

Not available with ground pin

#### P.C.B. MOUNTING HOLE

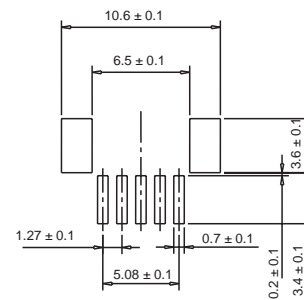

## PACKAGING

**Tape & Reel: M** 1000 pcs for reel

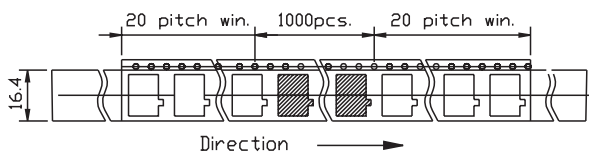

## LABELLING (on packaging)

The label tray gives full information on the products contained.

P/N:	
EL.FNC.:	
Q.TY:	
DATE CODE:	
Made in Taiwan	
Remarks	

A Bar code indicating Model, Quantity, Date Code enables easy traceability.